

## DATA SHEET

### MODULETEK: SFP-GE-BIDI-80KM-T1490/R1590-x-D10

1.25Gb/s SFP (Small Form Pluggable) Tx1490nm/Rx1590nm Bi-directional Transceiver

### Overview

ModuleTek's SFP-GE-BIDI-80KM-T1490/R1590-x-D10 SFP-BIDI optical transceivers are based on Gigabit Ethernet IEEE 802.3 standard and Fiber Channel FC-PI-2 Rev 7.0 , providing a fast and reliable interface for GE/FC applications. The product implements digital diagnostics via a 2-wire serial bus , compliant with the Small Form Factor Pluggable Multi-Source Agreement (MSA)and SFF-8472 standard.

### Product Features

- Up to 1.25 Gb/s data links
- Single LC connector
- Compliant with IEEE 802.3z Gigabit Ethernet
- Compliant with SFP MSA
- Hot-pluggable SFP footprint
- 1490nm DFB laser transmitter
- Built-in digital diagnostic functions
- Up to 80km on 9/125um SMF
- Single power supply 3.3V
- RoHS Compliant
- Class 1 laser product complies with EN 60825-1
- Operating temperature range(Case Temperature):  
Commercial Level : 0°C to 70°C  
Industrial Level : -40°C to 85°C



### Applications

- 1.25Gb/s Gigabit Ethernet
- 1.063Gb/s Fiber Channel

## Ordering Information

Part Number	Product ID	Description	Color on Clasp
SFP-GE-BIDI-80KM-T1490/R1590-C-D10	M311700	GE/FC,SFP-BIDI,Single LC Connector,Tx1490nm/Rx1590nm,80km,commercial temp	Purple
SFP-GE-BIDI-80KM-T1490/R1590-I-D10	M311702	GE/FC,SFP-BIDI,Single LC Connector,Tx1490nm/Rx1590nm,80km,industrial temp	Purple
<b>For More Information:</b> ModuleTek Limited Web: <a href="http://www.moduletek.com">www.moduletek.com</a> Email: <a href="mailto:sales@moduletek.com">sales@moduletek.com</a>			

## General Specifications

Parameter	Symbol	Min	Typ	Max	Unit	Remarks
Data Rate	DR		1.25		Gb/s	1
	DR		1.063		Gb/s	2
Bit Error Rate	BER			$10^{-12}$		
Operating Temperature	T <sub>C</sub>	0		70	°C	3
		-40		85	°C	3
Storage Temperature	T <sub>STO</sub>	-40		85	°C	4
Supply Current	I <sub>CC</sub>		230	300	mA	5
Input Voltage	V <sub>CC</sub>	3.14	3.3	3.46	V	
Maximum Voltage	V <sub>MAX</sub>	-0.5		4	V	5

### Notes:

1. IEEE 802.3
2. FC-PI-2 Rev7.0
3. Case temperature, commercial temperature
4. Ambient temperature
5. For electrical power interface

## Transmission distance

Data Rate	Optical Fiber type	Distance range (km)	Remark
1.25Gb/s	9/125um Singel mode fiber	80	

## Optical – Characteristics – Transmitter

$V_{CC}=3.14V$  to  $3.46V$ ,  $T_C$

Parameter	Symbol	Min	Typ	Max	Unit	Remarks
Output Optical Power	$P_{TX}$	0		5	dBm	1
Optical Center Wavelength	$\lambda_c$	1480	1490	1500	nm	
Extinction Ratio	ER	9			dB	
Spectral Width (-20dB)	$\Delta\lambda$			1	nm	
Optical Rise/Fall Time (20%-80%)	$t_r/t_f$		250	300	ps	

### Notes:

1. Class 1 Product

## Typical Eye Diagram

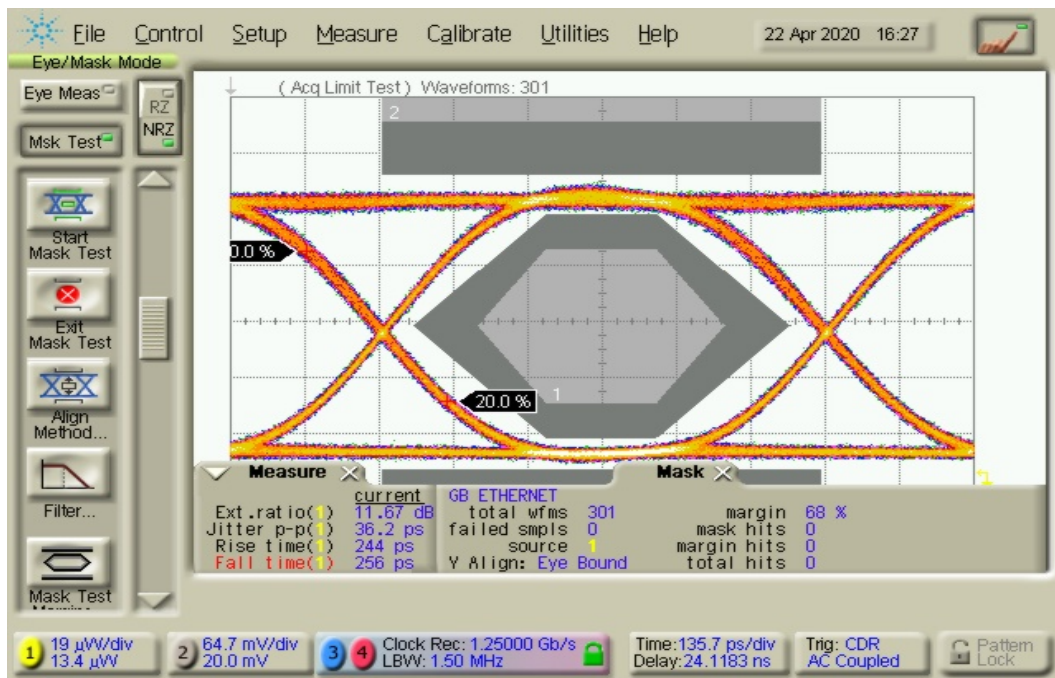

Data pattern: 1.25Gb/s, PRBS  $2^7-1$

## Optical – Characteristics – Receiver

$V_{CC}=3.14V$  to  $3.46V$ ,  $T_C$

Parameter	Symbol	Min	Typ	Max	Unit	Remarks
Receiver Overload	$P_{OL}$	0			dBm	
Optical Center Wavelength	$\lambda_C$	1570	1590	1610	nm	
Receiver Sensitivity	$R_{X\_SEN}$			-26	dBm	
Optical Return Loss	ORL	14			dB	
LOS Assert	$LOS_A$	-30			dBm	
LOS De-Assert	$LOS_D$			-28	dBm	
LOS Hysteresis	$LOS_H$	0.5			dB	

## Electrical – Characteristics – Transmitter

$V_{CC}=3.14V$  to  $3.46V$ ,  $T_C$

Parameter	Symbol	Min	Typ	Max	Unit	Remarks
Input differential impedance	$R_{IN}$		100		$\Omega$	
Single ended data input swing	$V_{IN\_PP}$	250		1200	mV	
Transmit disable voltage	$V_D$	$V_{CC}-1.3$		$V_{CC}$	V	
Transmit enable voltage	$V_{EN}$	$V_{EE}$		$V_{EE}+0.8$	V	
Transmit disable assert time				10	$\mu s$	

## Electrical – Characteristics – Receiver

$V_{CC}=3.14V$  to  $3.46V$ ,  $T_C$

Parameter	Symbol	Min	Typ	Max	Unit	Remarks
Single ended data output swing	$V_{OUT\_PP}$	300	400	800	mV	
Data output rise/fall time (20%-80%)	$t_r/t_f$			300	ps	
LOS Fault	$V_{LOS\_A}$	$V_{CC}-0.5$		$V_{CC\_HOST}$	V	
LOS Normal	$V_{LOS\_D}$	$V_{EE}$		$V_{EE}+0.5$	V	
<b>RX Squelch</b>	<b>Method of RX squelch implemented</b>				<b>Remarks</b>	
Not implemented	N.A					

## A0H Device register description

IIC Site	Byte size	Register name	Register description	Value(HEX)
0	1	Identifier	SFP	03
1	1	Extended Identifier	Use the IIC interface	04
2	1	Connector	Use the LC connector	07
3-10	8	Transceiver	1000 Base-BX-D	00 00 00 40 00 00 00 00
11	1	Encoding	Use the 8B/10B coding scheme	01
12	1	BR, Nominal	1.25Gb/s nominal rate	0D
13	1	Rate Identifier	No rate selection	00
14	1	Length(9μm)-km	In single-mode fiber transmission 80km	50
15	1	Length (9μm)-100m	In single-mode fiber transmission 80km	FF
16	1	Length (50μm)-10m	The transmission distance in the multimode fiber	00
17	1	Length (62.5μm)-10m	The transmission distance in the multimode fiber	00
18	1	Length (Copper)	The transmission distance over the copper cable	00
19	1	Reserved	Undefined	00
20-35	16	Trade name	MODULETEK	ASCII Format
36	1	Transceiver	Undefined	00
37-39	3	Vendor OUI	Vendor IEEE company ID	00 00 00
40-55	16	Vendor PN	Vendor's product model	Vendor defined
56-59	4	Vendor Revision Number	Vendor's product version number	Vendor defined
60-61	2	Wavelength	The laser has a wavelength of 1490 nanometers	05 D2
62	1	Reserved	Undefined	00
63	1	CC_BASE	0-62 Check and of bytes	Vendor defined
64-65	2	Transceiver Options	1.Rx_LOS Sigal monitoring 2.Tx_FAULT Sigal monitoring 3.Tx_DIS Sigal monitoring	00 1A
66	1	BR, max	High bit rate margin	00
67	1	BR, min	Low bit rate margin	00
68-83	16	Vendor SN	Vendor serial number	Vendor defined
84-91	8	Date code	The date code	Vendor defined
92	1	Monitoring Type	DOM Information internal calibration The received light power is measured using the average light power	68

93	1	Enhanced Options	1. Emitting light and receiving light alarm and warning monitoring 2. Tx_DIS Signal monitoring and control 3. Rx_LOS Signal monitoring 4. Tx_FAULT Signal monitoring	F0
94	1	Compliance	As defined in SFF-8472 in version 12.0	08
95	1	CC_EXT	64-94 Check and bytes	Vendor defined
96-127	32	Vendor Specific	Vendor custom areas	Vendor defined
128-255	128	Vendor Specific	Vendor custom areas	Vendor defined

## Digital Diagnostic Functions

SFP-GE-BIDI-80KM-T1490/R1590-x-D10 supports the 2-wire serial communication protocol as defined in SFP MSA . Digital diagnostic information is accessible over the 2-wire interface at the address 0xA2. Digital diagnostics for SFP-GE-BIDI-80KM-T1490/R1590-x-D10 are internally calibrated by default. The internal micro control unit accesses the device operating parameters in real time, Such as transceiver temperature, laser bias current, transmitted optical power, received optical power and transceiver supply voltage. The module implements the alarm function of the SFP MSA , alerts the user when a particular operating parameter exceeds the factory-set normal range.

## DDM Threshold Information

Parameter		Alarm Threshold		Warning Threshold	
		High Value	Low Value	High Value	Low Value
Temp (°C)	C	75 (4B 00)	-5 (FB 00)	70 (46 00)	0(00 00)
	I	90 (5A 00)	-45 (D3 00)	85 (55 00)	-40 (D8 00)
Voltage (V)		3.63(8D CC)	2.97 (74 04)	3.46 (87 28)	3.13 (7A 44)
Bias Current (mA)		100 (C3 50)	2 (03 E8)	80 (9C 40)	4 (07 D0)
Tx Power (dBm)		5.79 (94 3B)	-0.97 (1F 40)	5.00 (7B 86)	0 (27 10)
Rx Power (dBm)		3.01 (4E 20)	-30.46 (00 09)	0.00 (27 10)	-27.21 (00 13)

Parameter	Symbol	Accuracy	Units	Report Range		Unit	Remarks
Internal Calibration							
Temperature	Temp	±5	°C	-15	80	°C	
Voltage	V <sub>CC</sub>	±0.1	V	3.0	3.6	V	
Bias Current	I <sub>bias</sub>	±10	%	0	80	mA	
Tx Power	P <sub>TX</sub>	±3	dB	-6	1	dBm	
Rx Power	P <sub>RX</sub>	±3	dB	-24	-2	dBm	

## Block-Diagram-of-Transceiver

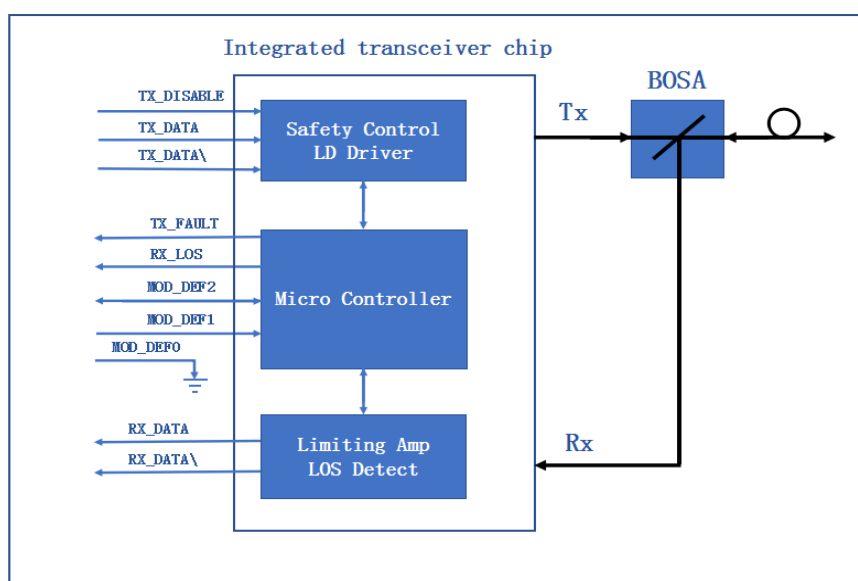

## Functions Description

The transmitter is mainly composed of a laser driver part of the intelligent transceiver chip and a TOSA (light-emitting component), the TOSA includes a 1490nm DFB laser and a backlight photodetection chip, When the module is working, the input signal is connected to the intelligent transceiver chip, at this time, the laser driver of the intelligent transceiver chip supplies the bias current and the modulation current to the laser.

The intelligent transceiver chip simultaneously uses an automatic optical power control (APC) feedback loop to maintain a constant average optical power of the laser output. The purpose is to eliminate the change of the output optical signal due to temperature changes and aging of the light source device.

When the transmitter enable pin (TX\_Disable) is high (TTL logic "1"), the laser output is turned off. When TX\_Disable is low (TTL logic "0"), the laser will turn on within 1ms. When the transmitter fault signal (TX\_Fault) is reported as high, indicates a transmitter failure caused by the transmitter's bias current or transmitted optical power or laser tube temperature exceeding a preset alarm threshold. Low indicates normal operation.

The receiver is mainly composed of a limiting amplifier part of the intelligent transceiver chip and a

ROSA (light-receiving component), the ROSA includes a PIN photodetector and a transimpedance amplifier chip. When the ROSA detects the incident light signal, it will be converted into a photo-generated current by the PIN photodetector. The photo-generated current is converted into an electrical signal after passing through the transimpedance amplifier. The electrical signal is further amplified by the limiting amplifier of the intelligent transceiver chip, then outputs a fixed-amplitude electrical signal to the host.

When the amplitude of the electrical signal received from the incident light conversion of the opposite optical transceiver module is lower than the set threshold, the module reports that the received signal is lost, the RX\_LOS pin is high (logic "1"), which can be used to diagnose whether the physical signal is normal. The signal is operated in TTL level. The implementation method of RX\_LOS is OMA (optical modulation amplitude).

The microprocessor inside the module monitors the module's operating voltage, temperature, transmitted optical power, received optical power, and laser bias current value in real time. The host acquires this information over a 2-wire serial bus.

## A0h/A2h Write Protection

Security Level 1 Password:

Password Entry ADDR	Size	Vaules(hex)	Remark
Page A2h, 7Bh-7Eh	4	12 34 56 78	

After the module is powered on, the read value of the security level access registers 7Bh to 7Eh of A2h is replaced with 0xFFh.

After entering the security level 1 working state, the user can directly write to the contents of the A0h device address and Table 00h and Table 01h of A2h device address.

And this version of the module does not support users to modify the security level 1 password.

## Product weight

Net weight of module: 18.5g/pcs

Net weight of dust cap: 0.65g/pcs



## Dimensions

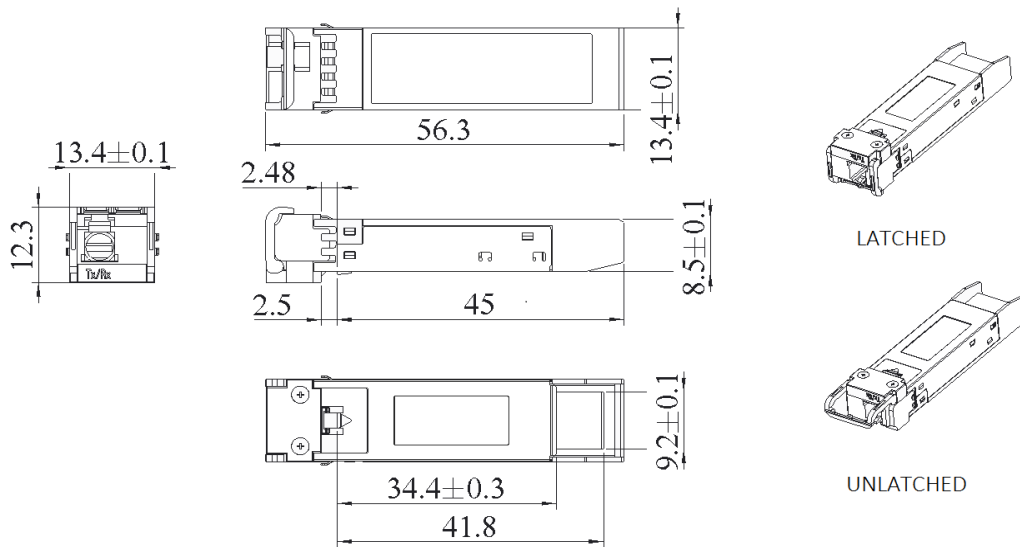

ALL DIMENSIONS ARE ±0.2mm UNLESS OTHERWISE SPECIFIED  
UNIT: mm

## Electrical Pad Layout

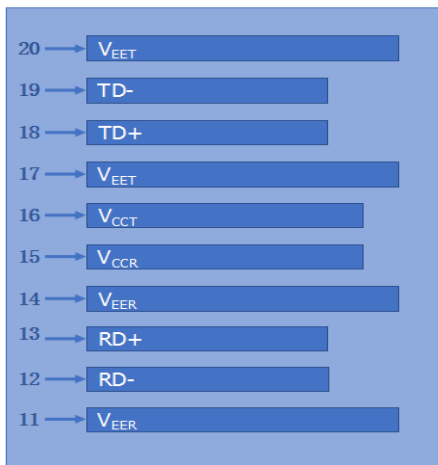

Top of Board

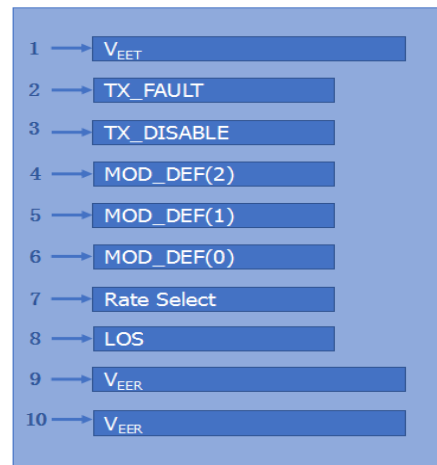

Bottom of Board

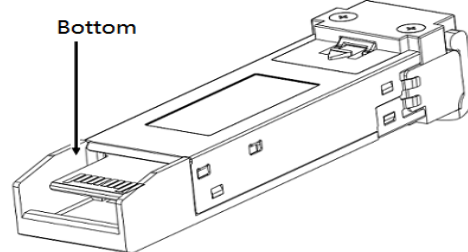
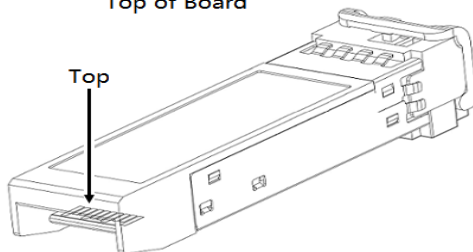

## Pin Assignment

PIN #	Symbol	Description	Remarks
1	V <sub>EET</sub>	Transmitter ground (common with receiver ground)	1
2	TX_FAULT	Transmitter Fault. Not supported	
3	TX_DISABLE	Transmitter Disable. Laser output disabled on high or open	2
4	MOD_DEF(2)	Module Definition 2. Data line for serial ID	3
5	MOD_DEF(1)	Module Definition 1. Clock line for serial ID	3
6	MOD_DEF(0)	Module Definition 0. Grounded within the module	3
7	Rate Select	No connection required	
8	LOS	Loss of Signal indication. Logic 0 indicates normal operation	4
9	V <sub>EER</sub>	Receiver ground (common with transmitter ground)	1
10	V <sub>EER</sub>	Receiver ground (common with transmitter ground)	1
11	V <sub>EER</sub>	Receiver ground (common with transmitter ground)	1
12	RD-	Receiver Inverted DATA out. AC coupled	
13	RD+	Receiver Non-inverted DATA out. AC coupled	
14	V <sub>EER</sub>	Receiver ground (common with transmitter ground)	1
15	V <sub>CCR</sub>	Receiver power supply	
16	V <sub>CCT</sub>	Transmitter power supply	
17	V <sub>EET</sub>	Transmitter ground (common with receiver ground)	1
18	TD+	Transmitter Non-Inverted DATA in. AC coupled	
19	TD-	Transmitter Inverted DATA in. AC coupled	
20	V <sub>EET</sub>	Transmitter ground (common with receiver ground)	1

### Notes:

1. Circuit ground is isolated from chassis ground
2. Disabled: T<sub>DIS</sub> > 2V or open, Enabled: T<sub>DIS</sub> < 0.8V
3. Should Be pulled up with 4.7k – 10k ohm on host board to a voltage between 2V and 3.6V
4. LOS is open collector output

## References

1. IEEE standard 802.3. IEEE Standard Department, 2008.
2. Small Form Factor Pluggable (SFP) Transceiver Multi-Source Agreement (MSA).
3. Fiber Channel Draft Physical Interface Specification (FC-PI-2 Rev7.0).
4. Digital Diagnostics Monitoring Interface for Optical Transceivers – SFF-8472.
5. Fiber Channel Physical and Signaling Interface (FC-PH/PH2/PH3).