

DATA SHEET

MODULETEK: SFP-25G-CSR-C-D15

25.78Gb/s SFP Short Wavelength (850nm) Transceiver

Overview

SFP-25G-CSR-C-D15 optical transceivers are based on 25G Ethernet IEEE 802.3 standard. They are compliant with FC-PI-6, SFF-8402, SFF-8419, SFF-8432 and SFF-8472, providing a fast and reliable interface for 25G Ethernet applications. The product implements the digital diagnostics required by the SFF-8472 via a 2-wire serial bus.

Product Features

- Up to 25.78Gbps bi-directional data links
- Compliant with IEEE 802.3
- Compliant with FC-PI-6
- Compliant with SFF-8402
- Compliant with SFF-8419
- Compliant with SFF-8432
- Compliant with SFF-8472
- Clock data recovery on transmit and receive channels CDR
- Hot-pluggable SFP footprint
- 850nm VCSEL laser transmitter
- Duplex LC connector
- Built-in digital diagnostic functions
- Up to 300m on OM3 MMF and 400m on OM4 MMF
- Single power supply 3.3V
- RoHS-6 Compliant
- Operating temperature range (Case Temperature) : Commercial Level : 0°C to 70°C



Applications

- 25GBASE-SR Ethernet
- eCPRI Wireless Networks

Ordering Information

Part Number	Product ID	Description	Color on Clasp
SFP-25G-CSR-C-D15	M008502	25GBASE-SR SFP 850nm LC Connectors, up to 300m(OM3) or 400m(OM4) on MMF, with DOM function	Black
Notes: 1.Product ID is the abbreviated order number of our company's product standard model			
For More Information Or To Order The Above Products, Please Contact: Email: sales@moduletek.com ModuleTek Web: www.moduletek.com			

General Specifications

Parameter	Symbol	Min	Typ	Max	Unit	Remarks
Operating Temperature	T _C	0		70	°C	1
Storage Temperature	T _{STO}	-40		85	°C	2
Supply Current	I _{CC}		145	290	mA	3
Input Voltage	V _{CC}	3.15	3.3	3.46	V	
Maximum Voltage	V _{MAX}	-0.5		4	V	3
Power Dissipation	P		550	700	mW	

Notes:

1. Case temperature
2. Ambient temperature
3. For electrical power interface

Link Distances

Parameter	Symbol	Min	Typ	Max	Unit	Remarks
Data rate	DR		25.78		Gbps	1
Bit error rate	BER			5x10 ⁻⁵		2
OM3 multimode fiber (bandwidth 2000MHz*km)	L			300	M	3
OM4 multimode fiber (bandwidth 4700MHz*km)	L			400	M	3

Notes:

1. IEEE802.3
2. Measured with data rate at 25.78Gbps, PRBS 2³¹-1
3. This module requires RS-FEC on the host ports for operation at 25G

Optical Characteristics – Transmitter

$V_{CC}=3.15V$ to $3.46V$, $T_C=0^{\circ}C$ to $70^{\circ}C$

Parameter	Symbol	Min	Typ	Max	Unit	Remarks
Average Output Optical Power	P_{TX}	-6		2.4	dBm	
Optical Center Wavelength	λ_C	840	850	863	nm	
Optical Modulation Amplitude	OMA	-6.4		3	dBm	
Extinction Ratio	ER	2			dB	
Spectral Width (RMS)	$\Delta\lambda$			0.6	nm	
Transmitter Dispersion Eye Closed	TDEC			4.3	dB	

Optical Characteristics – Receiver

$V_{CC}=3.15V$ to $3.46V$, $T_C=0^{\circ}C$ to $70^{\circ}C$

Parameter	Symbol	Min	Typ	Max	Unit	Remarks
Optical Center Wavelength	λ_C	840	850	863	nm	
Average Receiver Power@25.78Gbps	P_{RX}	-8.7		3	dBm	1
Optical Return Loss	ORL	12			dB	
LOS Assert	LOS_A	-30			dBm	
LOS De-Assert	LOS_D			-11	dBm	
LOS Hysteresis	LOS_H	0.5			dB	

Notes:

1. Measured with data rate at 25.78Gbps, PRBS $2^{31}-1$, BER 5×10^{-5} , without fiber

Electrical Characteristics – Transmitter

$V_{CC}=3.15V$ to $3.46V$, $T_C=0^{\circ}C$ to $70^{\circ}C$

Parameter	Symbol	Min	Typ	Max	Unit	Remarks
Input differential impedance	R_{IN}		100		Ω	
Differential data input swing	V_{IN_PP}	180		1600	mV	
Transmit Disable Voltage	V_D	2		V_{CC}	V	
Transmit Enable Voltage	V_{EN}	V_{EE}		$V_{EE}+0.8$	V	

Electrical Characteristics – Receiver

$V_{CC}=3.15V$ to $3.46V$, $T_C=0^{\circ}C$ to $70^{\circ}C$

Parameter	Symbol	Min	Typ	Max	Unit	Remarks
Differential output swing	V_{OUT_PP}	370	600	850	mV	
LOS Assert	LOS_A	2		V_{CC_HOST}	V	
LOS De-Assert	LOS_D	V_{EE}		$V_{EE}+0.8$	V	

Digital Diagnostic Functions

SFP-25G-CSR-C-D15 supports the 2-wire serial communication protocol defined in SFF-8472, which accesses digital diagnostic information through a 2-wire interface with the address 0xA2. The digital diagnosis defaults to internal calibration, and the internal micro-control unit accesses the module operating parameters in real time, such as module temperature, laser bias current, emission power, received light power and module power supply voltage. The module realizes the alarm function of SFF-8472, which sets the alarm flag bit when the specific working parameters are out of the normal range, and cancels the alarm flag bit when the specific working parameters return to the normal range.

Threshold range table

Parameter	High Alarm	High Warning	Low Warning	Low Alarm
Temperature($^{\circ}C$)	75.00(4B00h)	70.00(4600h)	0.00(0000h)	-5.00(FB00h)
Voltage(V)	3.63(8DCCh)	3.46(8728h)	3.13(7A44h)	2.97(7404h)
Bias Current(mA)	12.00(1770h)	11.50(1676h)	2.00(03E8h)	1.00(01F4h)
Tx Power(dBm)	5.40(8771h)	2.40(43E2h)	-6.00(09CFh)	-10.00(03E8h)
Rx Power(dBm)	5.40(8771h)	2.40(43E2h)	-8.70(0544h)	-12.70(0219h)

A0h、A2h Write Protection

Security Level 1 Password (Factory value)		
Password Entry ADDR	Size	Vaules(HEX)
Page A2h, 7Bh-7Eh	4	00 00 10 11
Change Security Level 1 Password		
Change Password Entry ADDR	Size	Vaules(HEX)
Page A2h, Table F0h, 80h-83h	4	Programmed by User

SFP-25G-CSR-C-D15 has write protection functions of A0h and A2h, and users can enter the working state of security level 1 and write to the address of module device A0h and table 00h, table 01h and table F0h of A2h. The method to enter the working state of security level 1 is to write the security level 1 password in the 7Bh-7Eh register of the module A2h address in turn. After entering the security level 1, the user can directly write the contents of the A0h device address, or by modifying the contents

of the 7Fh table selection register in the A2h address, write to table 00h or table 01h or table F0h. This version module supports users to modify the password of security level 1 by writing a new security level 1 password in the 80h-83h register in the device address F0h table of module A2h.

IIC Memory Map(Page A0 HEX, Unlisted Fields are Blank/Empty)

IIC ADDR	Size	Name	Description	Vaules(HEX)
0	1	Identifier	SFP	03
1	1	Ext. Identifier	Two-wire Interface	04
2	1	Connector	Connector Type=LC	07
3-10	8	Transceiver	25G Base SR	00 00 00 00 00 00 00 00
11	1	Encoding	Code for high speed serial encoding 64B/66B	06
12	1	BR,Nominal	Nominal Bit Rate 25.78Gbps	FF
13	1	Rate Identifier	Type of rate select functionality	00
14	1	Length(9um)-km	Link Length in Thousands of Meters/SMF=NA	00
15	1	Length(9um)-100m	Link Length in Hundreds of Meters/SMF=NA	00
16	1	Length(50um)-10m	50-micron MMF Link Length=NA	00
17	1	Length(62.5um)-10m	62.5-micron MMF Link Length=NA	00
18	1	Length(OM4)-10m	400m Link Length in OM4 MMF	28
19	1	Length(OM3)-10m	300m Link Length in OM3 MMF	1E
20-35	16	Vendor name	MODULETEK	ASCII Format
36	1	Transceiver	25G Base SR	02
37-39	3	Vendor OUI	SFP Vendor IEEE Company ID	00 00 00
40-55	16	Vendor PN	Part number provided by SFP vendor	ASCII Format
56-59	4	Vendor rev	Revision level for part number provided by vendor	Programmed by Factory
60-61	2	Wavelength	Laser Wavelength=850nm	03 52
62	1	Reserved	Unallocated	00
63	1	CC_BASE	Check sum of bytes 0-62	Programmed by Factory

64	1	Transceiver Options	<p>BIT7=0 Reserved</p> <p>BIT6=0 Reserved</p> <p>BIT5=0 The module power level is 1(Less than 1.0w)</p> <p>BIT4=1 Paging implemented function</p> <p>BIT3=1 Retimer or CDR indicator</p> <p>BIT2=0 A uncooled laser transmitter implementation</p> <p>BIT1=0 The module power Level is 1(Less than 1.0w)</p> <p>BIT0=0 A conventional limiting receiver output</p>	18
65	1	Transceiver Options	<p>BIT7=0 Receiver decision threshold implemented is not realized</p> <p>BIT6=0 Tunable wavelength lasers are not used</p> <p>BIT5=0 RATE_SELECT functionality is not realized</p> <p>BIT4=1 Have TX_DIS function</p> <p>BIT3=1 Have TX_Fault function</p> <p>BIT2=0 Loss of Signal is not realized</p> <p>BIT1=1 Have RX_LOS function</p> <p>BIT0=0 Reserved</p>	1A
66	1	BR,max	Maximum signal rate	67
67	1	BR,min	Maximum signal rate deviation	00
68-83	16	Vendor SN	Vendor SN	Programmed by Factory
84-91	8	Date code	Year,Month,Day	Programmed by Factory
92	1	Diagnostic Monitoring Type	<p>BIT7=0 Compatible with SFF-8472 requirements</p> <p>BIT6=1 Realize digital diagnostic function</p> <p>BIT5=1 Realized internal calibration function</p> <p>BIT4=0 Externally calibration is not realized</p> <p>BIT3=1 Received power is the averaged power</p> <p>BIT2=0 Don't need address change</p> <p>BIT1=0 Reserved</p> <p>BIT0=0 Reserved</p>	68
93	1	Enhanced Options	<p>BIT7=1 Have optional Alarm/Warning flags implementes function</p> <p>BIT6=1 Have soft TX_DIS monitor and control functions</p> <p>BIT5=1 Have soft TX_Fault monitor function</p> <p>BIT4=1 Have soft RX_LOS monitor function</p> <p>BIT3=0 No software RATE_SEL monitor and control functions</p> <p>BIT2=0 The optional soft rate selection control funtion is not implemented by SFF-8079</p> <p>BIT1=0 The optional soft rate selection control funtion is not implemented by SFF-8431</p> <p>BIT0=0 Reserved</p>	F0
94	1	SFF-8472 Compliance	As defined by SFF8472 version 12.3	08
95	1	CC_BASE	Check sum of bytes 64-94	Programmed by Factory
96-127	32	Vendor Specific	Vendor Specific EEPROM	Programmed by Factory

128-255	128	Reserved	Vendor Specific	Programmed by Factory
---------	-----	----------	-----------------	-----------------------

IIC Memory Map(Page A2 HEX LOW, Unlisted Fields are Blank/Empty)

IIC ADDR	Size	Name	Description	Vaules(HEX)
Alarm/Warning Thresholds				
00-01	2	Temp High Alarm	Temperature high alarm	See Table Of Threshold Ranges
02-03	2	Temp Low Alarm	Temperature low alarm	See Table Of Threshold Ranges
04-05	2	Temp High Warning	Temperature high warning	See Table Of Threshold Ranges
06-07	2	Temp Low Warning	Temperature low warning	See Table Of Threshold Ranges
08-09	2	Voltage High Alarm	Voltage high alarm	See Table Of Threshold Ranges
10-11	2	Voltage Low Alarm	Voltage low alarm	See Table Of Threshold Ranges
12-13	2	Voltage High Warning	Voltage high warning	See Table Of Threshold Ranges
14-15	2	Voltage Low Warning	Voltage low warning	See Table Of Threshold Ranges
16-17	2	Bias High Alarm	Bias current high alarm	See Table Of Threshold Ranges
18-19	2	Bias Low Alarm	Bias current low alarm	See Table Of Threshold Ranges
20-21	2	Bias High Warning	Bias current high warning	See Table Of Threshold Ranges
22-23	2	Bias Low Warning	Bias current low warning	See Table Of Threshold Ranges
24-25	2	TX Power High Alarm	TX power high alarm	See Table Of Threshold Ranges

26-27	2	TX Power Low Alarm	TX power low alarm	See Table Of Threshold Ranges
28-29	2	TX Power High Warning	TX power high warning	See Table Of Threshold Ranges
30-31	2	TX Power Low Warning	TX power low warning	See Table Of Threshold Ranges
32-33	2	RX Power High Alarm	RX power high alarm	See Table Of Threshold Ranges
34-35	2	RX Power Low Alarm	RX power low alarm	See Table Of Threshold Ranges
36-37	2	RX Power High Warning	RX power high warning	See Table Of Threshold Ranges
38-39	2	RX Power Low Warning	RX power low warning	See Table Of Threshold Ranges
40-55	16	Optional A/W Thresholds	Unrealized	–
Calibration Constant For External Calibration Option				
56-59	4	RX-PWR(4)	The module only realizes internal correction funtion	00 00 00 00
60-63	4	RX_PWR(3)	The module only realizes internal correction funtion	00 00 00 00
64-67	4	RX_PWR(2)	The module only realizes internal correction funtion	00 00 00 00
68-71	4	RX_PWR(1)	The module only realizes internal correction funtion	3F 80 00 00
72-75	4	RX_PWR(0)	The module only realizes internal correction funtion	00 00 00 00
76-77	2	TX_I(Slope)	The module only realizes internal correction funtion	01 00
78-79	2	TX_I(Offset)	The module only realizes internal correction funtion	00 00
80-81	2	TX_PWR(Slope)	The module only realizes internal correction funtion	01 00
82-83	2	TX_PWR(Offset)	The module only realizes internal correction funtion	00 00
84-85	2	T(Slope)	The module only realizes internal correction funtion	01 00
86-87	2	T(Offset)	The module only realizes internal correction funtion	00 00
88-89	2	V(Slope)	The module only realizes internal correction funtion	01 00
90-91	2	V(Offset)	The module only realizes internal correction funtion	00 00
92-94	3	Unallocated	–	00 00 00
95	1	Checksum	Byte 95 contains the low order 8 bits of the sum of bytes 0-94	–
A/D Values And Status Bits				
96-97	2	Temperature MSB/LSB	Temperature measured value	Variable
98-99	2	Vcc MSB/LSB	Voltage measured value	Variable
100-101	2	Tx Bias MSB/LSB	Bias current measured value	Variable

102-103	2	TX Power MSB/LSB	Measured TX output power	Variable
104-105	2	RX Power MSB/LSB	Measured RX input power	Variable
106-107	2	Laser T/W MSB/LSB	Function not implemented	00 00
108-109	2	TEC current MSB/LSB	Function not implemented	00 00
110	1	Status/Control	BIT7 TX_Dis Pin States BIT6 Soft TX_Dis Pin States BIT5 RS(1) Pin States BIT4 RS0 Pin States BIT3 Soft RS0 control bit BIT2 TX_Fault Pin States BIT1 Rx_LOS Pin States BIT0 Data_Ready_Bar Pin States	Variable
111	1	Reserved	Reserved for SFF-8079	00
112	1	Alarm Flags	BIT7 Temp High Alarm BIT6 Temp Low Alarm BIT5 Vcc High Alarm BIT4 Vcc Low Alarm BIT3 TX Bias High Alarm BIT2 TX Bias Low Alarm BIT1 TX Power High Alarm BIT0 TX Power Low Alarm	Variable
113	1	Alarm Flags	BIT7 RX Power High Alarm BIT6 RX Power Low Alarm BIT5-BIT2 Alarm bit not realized BIT1-BIT0 Reserved	Variable
114	1	Tx Input EQ Control	BIT7-BIT4 High-speed mode input equalization setting value; the default value for power-up is 3, which can be used to change the module input equalization value BIT3-BIT0 Low-speed mode input equalization setting value; not used, the default value for power-up is 3	33
115	1	Rx Out Emphasis Control	BIT7-BIT4 High-speed mode output emphasis setting value; the default value for power-up is 3, which can be used to change the module output emphasis value BIT3-BIT0 Low-speed mode output emphasis setting value; not used, the default value for power-up is 3	33
116	1	Warning Flags	BIT7 Temp High Warning BIT6 Temp Low Warning BIT5 Vcc High Warning BIT4 Vcc Low Warning BIT3 TX Bias High Warning BIT2 TX Bias Low Warning BIT1 TX Power High Warning BIT0 TX Power Low Warning	Variable

117	1	Warning Flags	BIT7 RX Power High Warning BIT6 RX Power Low Warning BIT5-BIT2 Warning bit not realized BIT1-BIT0 Reserved	Variable
118	1	Ext Status/Control	BIT7-BIT4 BIT2 Reserved BIT3 Soft RS(1) control bit BIT1=0 The module power level is 1 (Less than 1.0w) BIT0=0 The module power level is 1 (Less than 1.0w)	The default for power-up is 00
119	1	Ext Status/Control	BIT7-BIT5 Unallocated BIT4=0 Not Applicable BIT3=0 Not Applicable BIT2=0 Not Applicable BIT1 TX CDR status bit, a value of 0 indicates that the CDR is locked, whereas a value of 1 indicates loss of lock of the CDR BIT0 Rx CDR status bit, a value of 0 indicates that the CDR is locked, whereas a value of 1 indicates loss of lock of the CDR	Variable
General Use Fields				
120-122	3	Reserved	Reserved	00 00 00
123-126	4	Security Level Password	Security level password input area, the written password can be displayed and the default value is 00 00 00 00	00 00 00 00
127	1	Table Select	Table Select	00

Block-Diagram-of-Transceiver

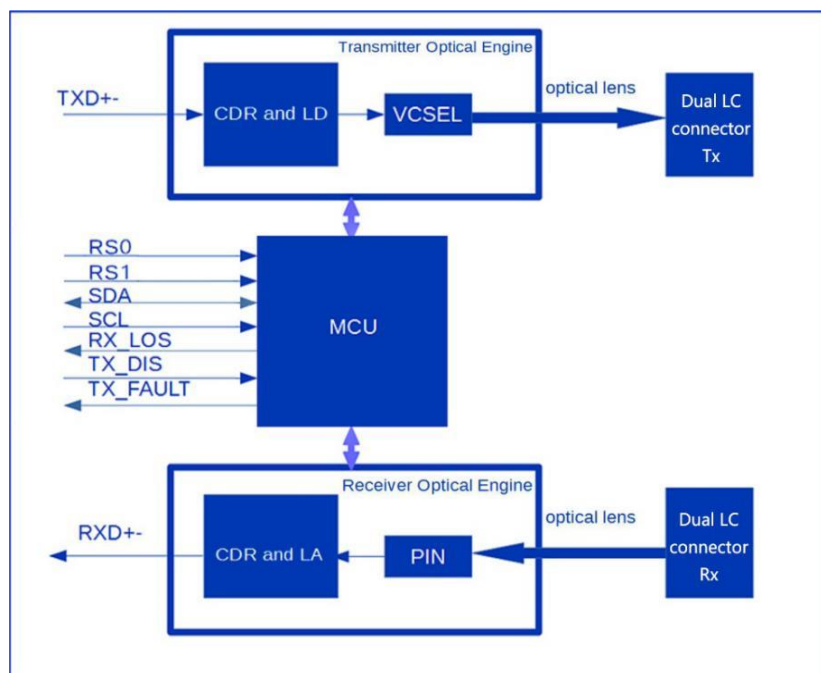

Functions Description

SFP-25G-CSR-C-D15 module is manufactured by advanced COB (Chip on Board) technology and consists of a microcontroller, an optical engine at the transmitting end and an optical engine at the receiving end. The module has built-in clock and data recovery functions, and the working rate range of the transmitter and receiver of the built-in CDR is 25.2-28.1Gbps. If you need another version of the rate range, you can contact us for special customization.

The microcontroller communicates with the host through a 2-wire serial communication interface, providing module control function, status reporting function and monitoring function (DOM). This product conforms to the SFF-8472 standard.

The transmitter optical engine includes a transmitter clock data recovery circuit (CDR) and a laser driver circuit (LD), a VCSEL laser, and a detection photodiode (MPD). The high-speed differential electrical signal output by the host computer is restored and shaped by the CDR, which is amplified by the laser driver to drive the VCSEL laser to produce the optical signal, and the optical signal is coupled to the optical fiber through the optical lens. The optical engine integrates a photodiode for detection, which is used for output optical power detection.

The receiving optical engine includes a photodiode (PIN), a signal amplifier (TIA/LA) and a receiver clock data recovery circuit (CDR). The optical signal in the optical fiber is coupled to the receiving photodiode (PIN) through an optical lens and converted into photocurrent. After the photocurrent signal is enhanced by the amplifier, it is sent to the CDR circuit and the clock and data signal recovery is completed. Finally, it is output to the host in the form of high-speed differential signal. The microcontroller reads the signal strength (modulation amplitude) received by the photodiode and reports the loss of the received signal if it is lower than the set threshold.

Both the transmitter and receiver have the function of suppression. When there is a signal input at the transmitter, the waveform displayed by the transmitted light access oscilloscope is an eye graph shape, and when there is no signal input, the waveform displayed by the transmitted light access oscilloscope is a straight line, and the actual measured optical power is lower than the normal optical power value, but not zero. When the incident light at the receiving has a signal input, the access oscilloscope shows that the waveform of the output electrical signal is an eye graph shape, and when there is no signal input, the oscilloscope shows that the waveform of the output electrical signal is a straight line.

Dimensions

Module Weight: 16.0 g
Dust Cap Weight: 0.95 g

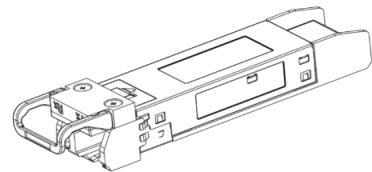
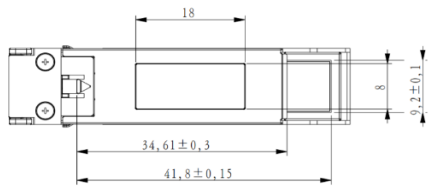
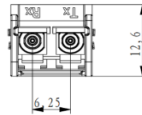
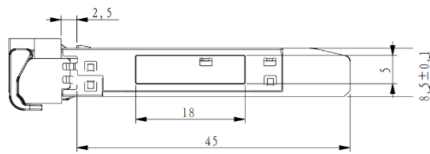
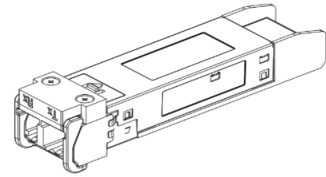
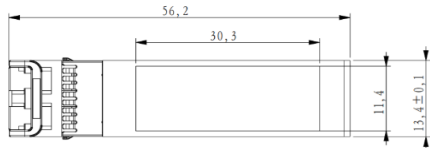

ALL DIMENSIONS ARE ± 0.2 mm UNLESS OTHERWISE SPECIFIED
UNIT: mm

Electrical Pad Layout

Top View Of Board

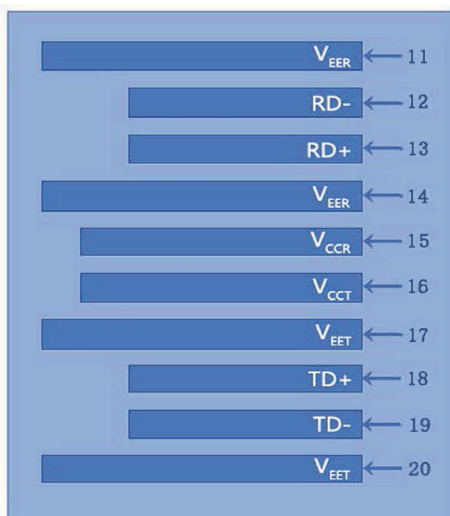

Bottom View Of Board

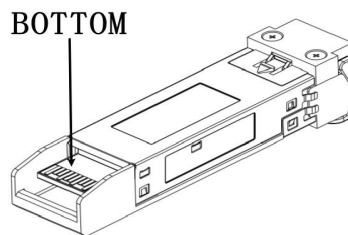
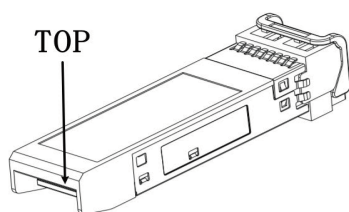
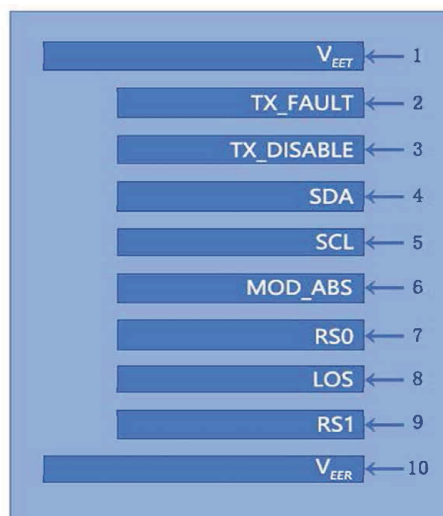

Typical Eye Diagram

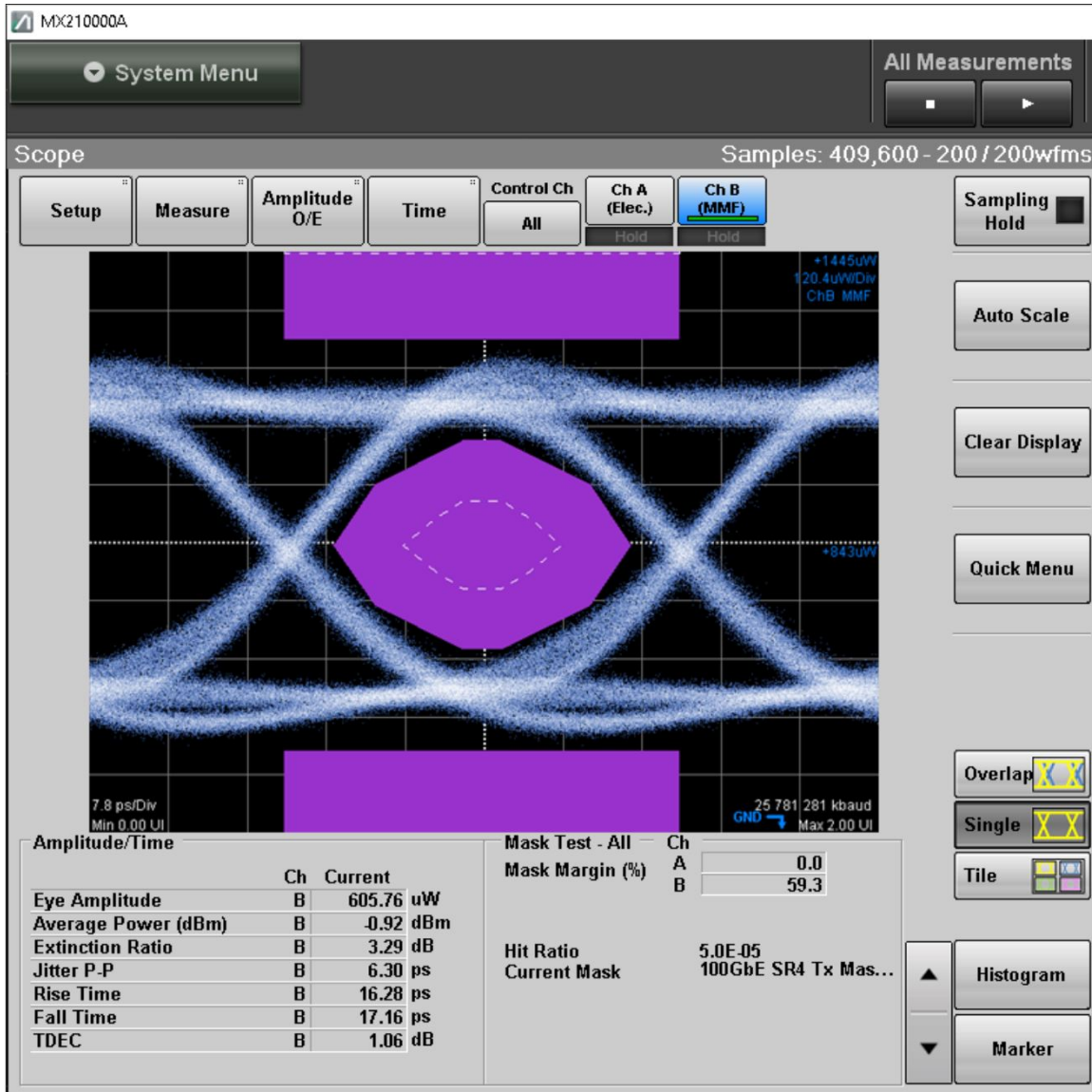

Pin Assignment

PIN #	Symbol	Description	Remarks
1	V _{EET}	Transmitter ground (common with receiver ground)	1
2	TX_FAULT	Transmitter Fault	
3	TX_DISABLE	Transmitter Disable. Laser output disabled on high or open	2
4	SDA	2-wire Serial Interface Data Line	3
5	SCL	2-wire Serial Interface Clock Line	3
6	MOD_ABS	Module Absent. Grounded within the module	3
7	RS0	No connection required	
8	LOS	Loss of Signal indication. Logic 0 indicates normal operation	4
9	RS1	No connection required	1
10	V _{EER}	Receiver ground (common with transmitter ground)	1
11	V _{EER}	Receiver ground (common with transmitter ground)	1
12	RD-	Receiver Inverted DATA out. AC coupled	
13	RD+	Receiver Non-inverted DATA out. AC coupled	
14	V _{EER}	Receiver ground (common with transmitter ground)	1
15	V _{CCR}	Receiver power supply	
16	V _{CCT}	Transmitter power supply	
17	V _{EET}	Transmitter ground (common with receiver ground)	1
18	TD+	Transmitter Non-Inverted DATA in. AC coupled	
19	TD-	Transmitter Inverted DATA in. AC coupled	
20	V _{EET}	Transmitter ground (common with receiver ground)	1

Notes:

1. Circuit ground is isolated from chassis ground
2. Disabled: T_{DIS}>2V or open, Enabled: T_{DIS}<0.8V
3. Should Be pulled up with 4.7k –10k ohm on host board to a voltage between 2V and 3.6V
4. LOS is open collector output

References

1. IEEE standard 802.3. IEEE Standard Department, 2018
2. FIBRE CHANNEL Physical Interface-6(FC-PI-6). Rev3.10 October 25, 2013
3. SFF-8402 SFP+ 1X28 Gb/s Pluggable Transceiver Solution(SFP28). Rev1.1 September 13, 2014
4. SFF-8419 SFP+ Power and Low Speed Interface. Rev1.3 June 11, 2015
5. SFF-8432 SFP+ Module and Cage. Rev5.2a November 30, 2018
6. SFF-8472 Management Interface for SFP+. Rev12.3 July 29, 2018